

Drip Tray Installation Instructions

EZYTRAY2 & EZYTRAY3



EZYTRAY2

(Shown with EZYTAP 75/7800)



EZYTRAY3

(Shown with EZYTAP 75T/7800T)



EZYTRAY3

(Shown with EZYTAP AC)

PARTS PROVIDED FOR THE EZYTRAY2 & EZYTRAY3

- A. EZYTRAY2 Grill and EZTRAY2TEMPLATE, various screws, washers, an O ring, and tools. AA will add a drain away kit (C) which includes a 1m length 22mm internal diameter waste pipe to connect to waste.

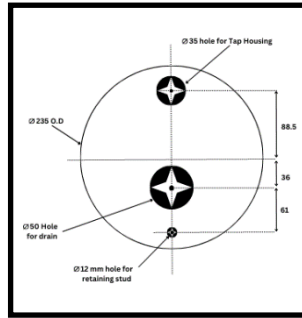

EZTRAY2TEMPLATE
Installation Template



EZYTRAY2: Parts
Breakdown

- B. EZYTRAY3 Grill and EZTRAY3TEMPLATE, various screws, washers, an O ring, and tools. AA will add a drain away kit (C) which includes a 1m length 22mm internal diameter waste pipe to connect to waste.

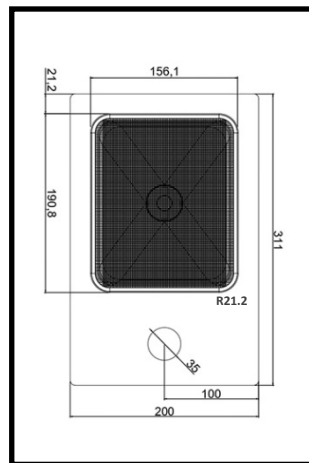

EZTRAY3TEMPLATE
Installation Template

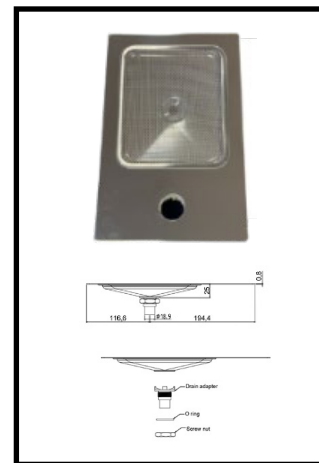

EZYTRAY3: Parts
Breakdown

C.

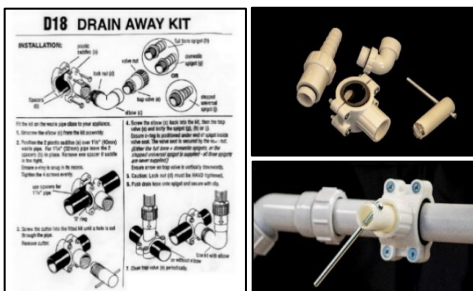

EZYTRAY2 & EZYTRAY3 INSTALLATION GUIDE

- Before starting any work, ensure that the data cable and pipes are connected to the tap within easy reach of the EZYTAP under sink unit. Please note that the data cable cannot be extended or shortened. Also ensure that the mains waste is nearby to connect to the EZYTRAY2/3 waste elbow.
- Position the EZYTRAY2/3 Template on the work surface and drill the holes in the counter as shown on the Template.
- Secure EZYTRAY2 with fixing rod at the front with the bolt provided.
- Fit waste elbow to centre of the EZYTRAY2/3 with the tightening nut provided, with the elbow pointing in the direction of the mains waste.
- Connect the EZYTRAY2/3 waste pipe to the EZYTRAY2/3 waste elbow.
- Clamp the self-cutting valve to the mains waste pipe and by using the cutting tool provided cut an access hole. Attach waste pipe.
- Now begin fixing the EZYTAP to the EZYTRAY and work surface.
 - Attach screw bolts to bottom of tap.
 - Feed the data cable and pipes through the hole provided for the EZYTAP.
 - Secure the EZYTAP with the C clamp, washers, and nuts to the counter.
 - Connect the data cable and pipes to the EZYTAP unit.